









 MINIFIX SHAFT x 20	 MINIFIX HEAD x 20	 DOWEL : x 52	 PULLING SCREW x 12
 HOLDER x 4	 HOLDER SCREW x 8	 CORNER WEDGE x 10	 CABINET SCREW x 10
 4x18 CHIPBOARD SCEW x 42	 FOOT SEAL x 8	 35 CM TELESCOPIC RAIL x 4	

\* FIX THE ACCESORIES AS SHOWN FOLLOW THE INSTALLATION SEQUENCE WHILE INSTALLING THE PRODUCT .



## UV2230403 COSMO LUNA (CHEST OF DRAWERS ) ASSEMBLY GUIDE



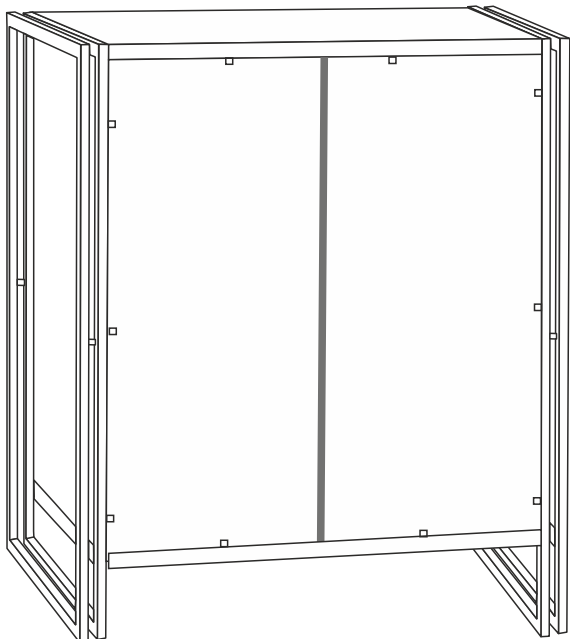
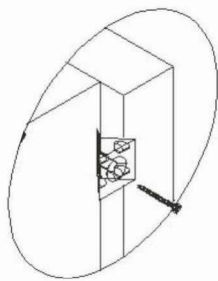
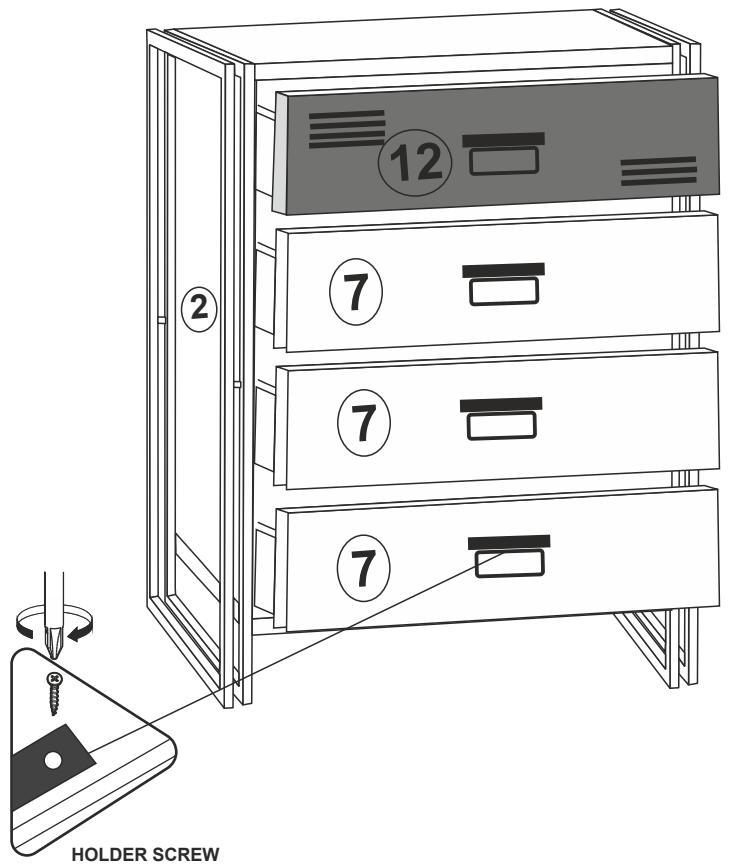
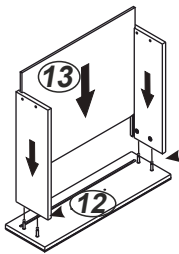
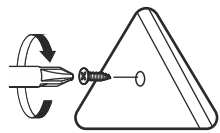
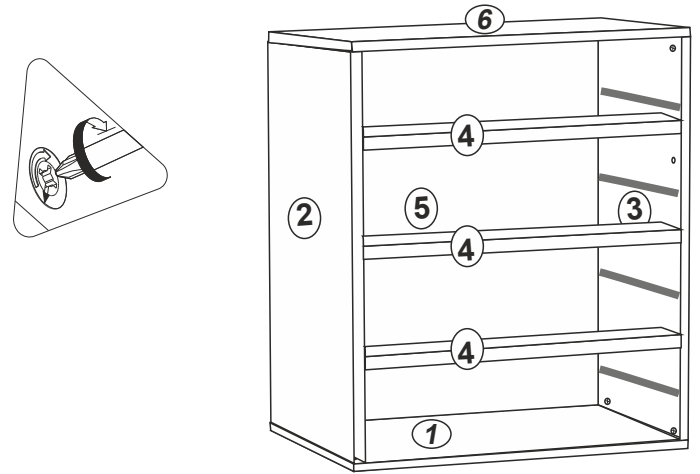
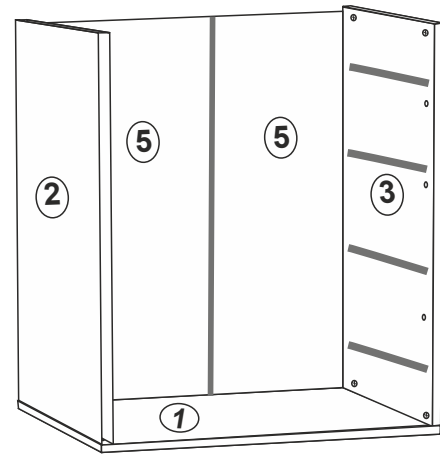
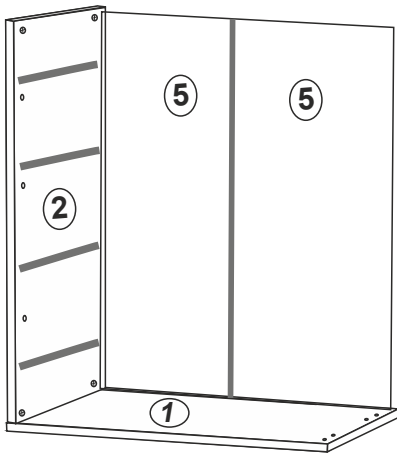
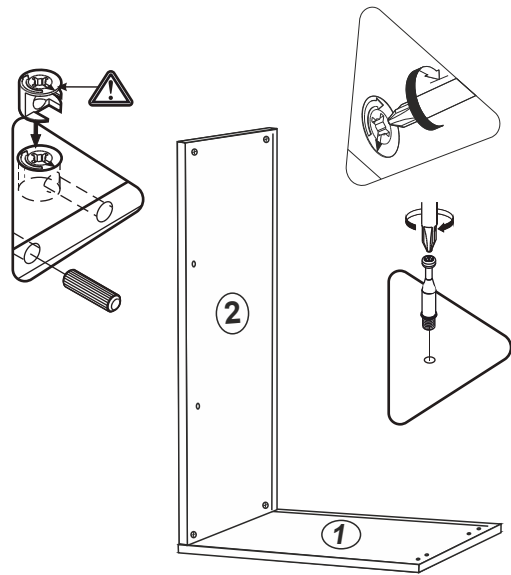

UPPER DRAWER

